

Timing Belt: Service and Repair

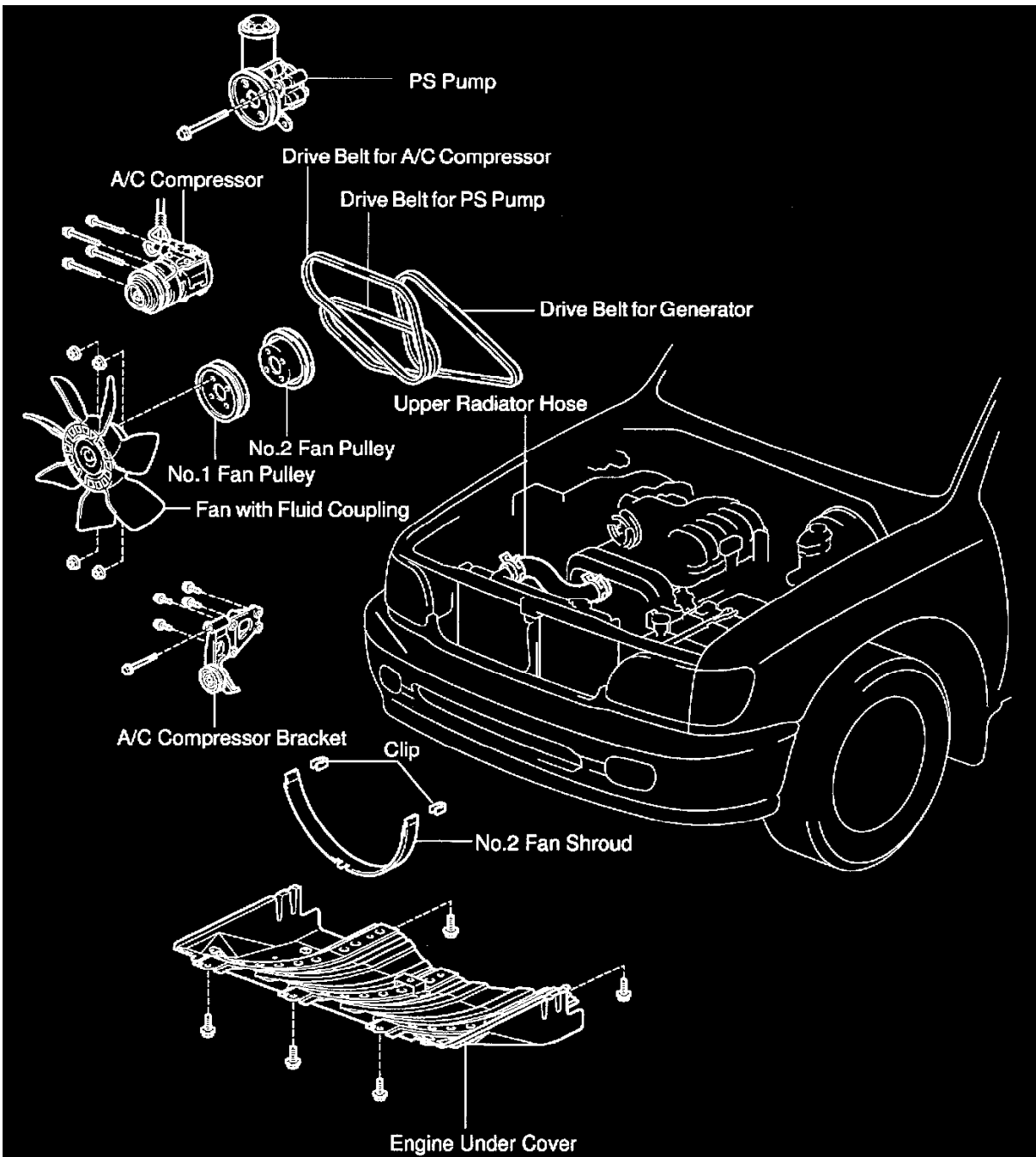

**REMOVAL**

1. REMOVE ENGINE UNDER COVER
2. DRAIN ENGINE COOLANT
3. DISCONNECT UPPER RADIATOR HOSE

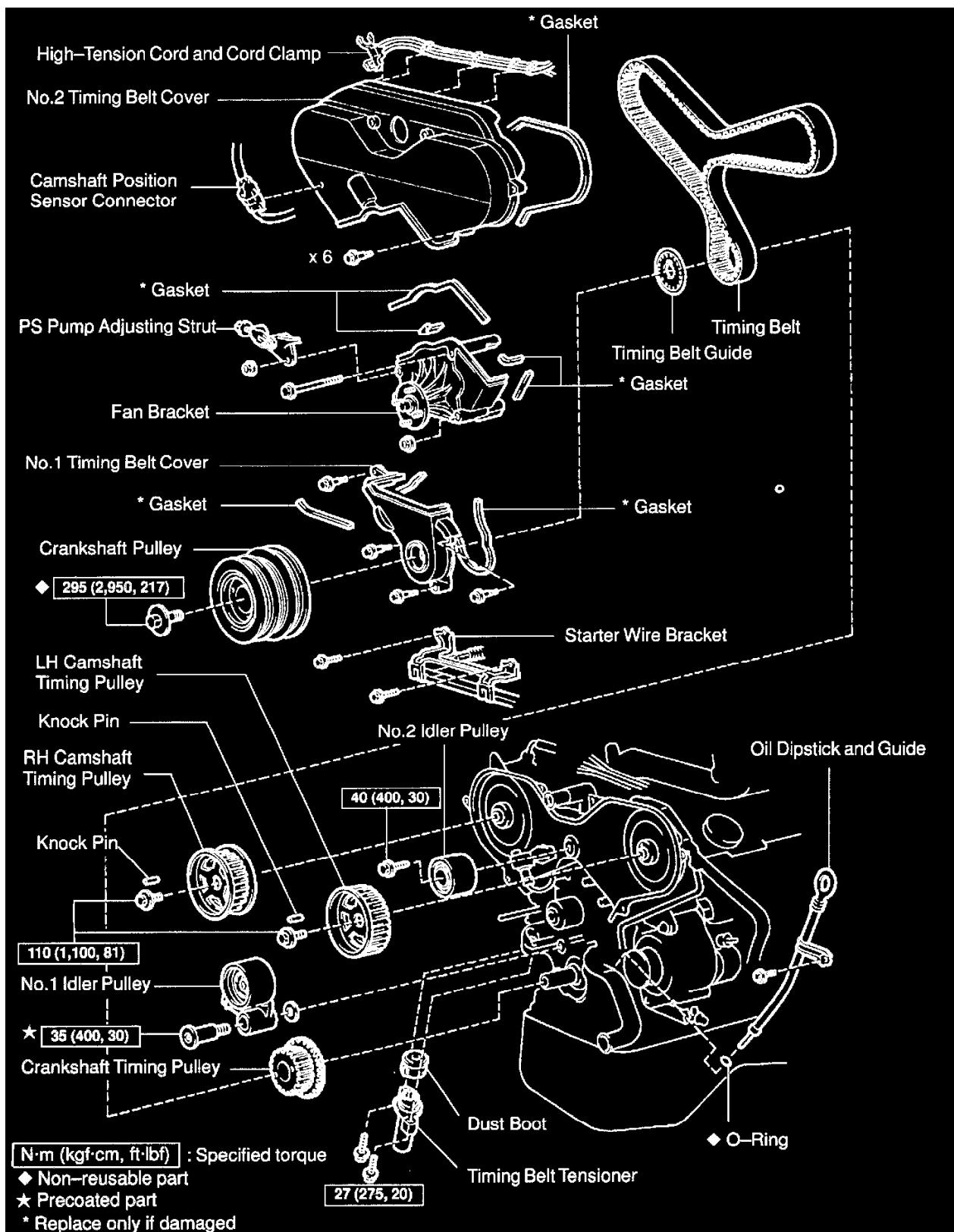
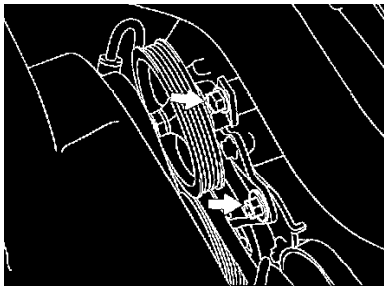

4. DISCONNECT PS PUMP FROM ENGINE

- a. Disconnect the 2 PS air hoses from the air intake chamber and resonator.
- b. Remove the bolt holding the PS pressure tube clamp to the frame.
- c. Remove the drive belt.
- d. Remove the bolt and nut, and disconnect the PS pump from the engine.

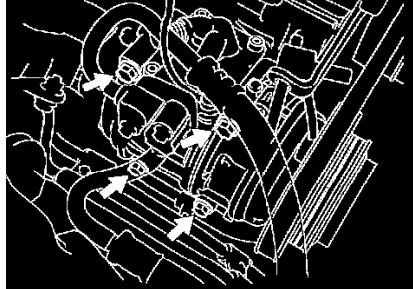

5. w/ A/C:

DISCONNECT A/C COMPRESSOR FROM ENGINE

- a. Disconnect the A/C compressor connector.
- b. Remove the drive belt.
- c. Remove the 4 bolts, and disconnect the A/C compressor from the engine.

6. LOOSEN FAN WITH FLUID COUPLING AND FAN PULLEYS

7. REMOVE DRIVE BELT FOR GENERATOR

8. REMOVE NO.2 FAN SHROUD

9. REMOVE FAN WITH FLUID COUPLING AND FAN PULLEYS

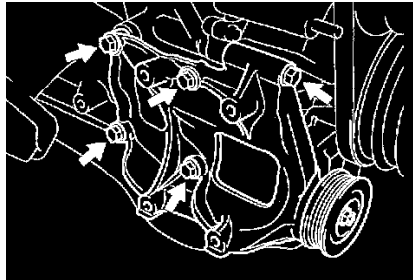

10. w/ A/C:

REMOVE A/C COMPRESSOR BRACKET

Remove the 5 bolts and A/C compressor bracket.

11. DISCONNECT UPPER RADIATOR HOSE

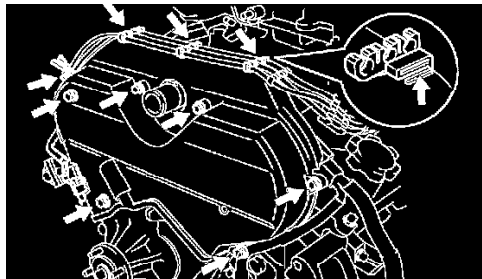

12. REMOVE NO.2 TIMING BELT COVER

- a. Disconnect the camshaft position sensor connector from the No. 2 timing belt cover.
- b. Disconnect the 4 high-tension cord clamps from the No. 2 timing belt cover.

- c. Remove the 6 bolts and timing belt cover.



13. REMOVE FAN BRACKET

- Remove the nut and PS pump adjusting strut.
- Remove the bolt, nut and fan bracket.

14. SET NO. 1 CYLINDER AT TDC/COMPRESSION

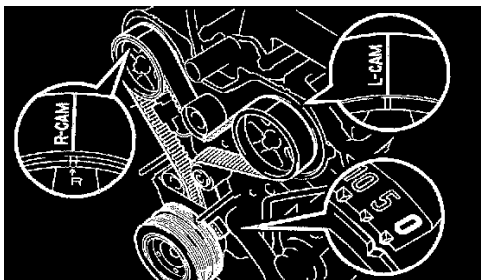

- Turn the crankshaft pulley and align its groove with timing mark "0" of the No. 1 timing belt cover.



- Check that the timing marks of the camshaft timing pulleys and No. 3 timing belt cover are aligned. If not, turn the crankshaft pulley **1 revolution (360°)**.

HINT: When re-using timing belt: Place the matchmarks on the timing belt and camshaft timing pulleys, and place matchmark on timing belt to match the end of the No. 1 timing belt cover.

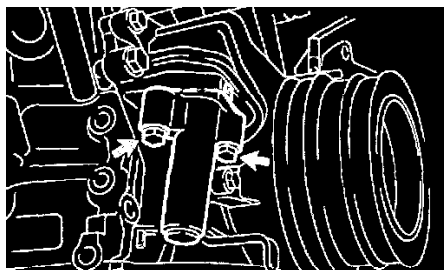

15. REMOVE TIMING BELT TENSIONER

Alternately loosen the 2 bolts, and remove them, the belt tensioner and dust boot.

16. REMOVE TIMING BELT

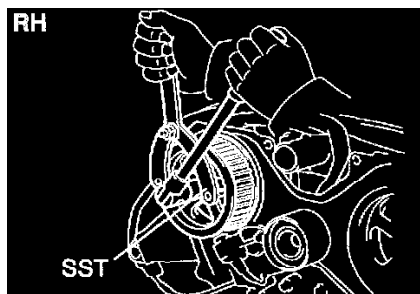

17. REMOVE RH CAMSHAFT TIMING PULLEY

Using SST, loosen the pulley bolt.

SST 09960-10010 (09962-01000, 09963-01000)

18. REMOVE LH CAMSHAFT TIMING PULLEY

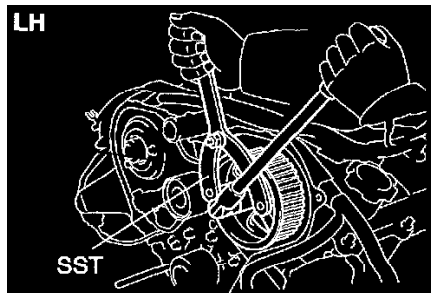

a. Using SST, loosen the pulley bolt.

SST 09960-10011 (09962-01000, 09963-01000)

b. Remove the bolt, knock pin and camshaft timing pulley.

19. REMOVE CRANKSHAFT PULLEY

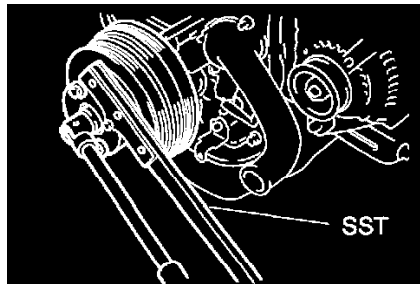

a. Using SST, loosen the pulley bolt.

SST 09213-54015 (90119-08216), 09330-00021

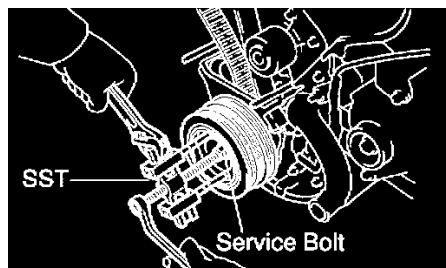

b. Remove the SST, pulley bolt and pulley.

HINT: If necessary, remove the pulley with SST and service bolt.

SST 09950-50013 (09551-05010, 09552-05010, 09553-05020, 09554-05031)

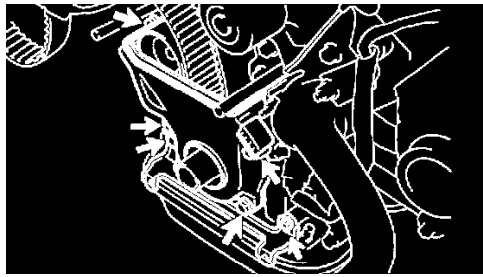

20. REMOVE STARTER WIRE BRACKET AND NO. 1 TIMING BELT COVER

- Remove the 2 bolts and starter wire bracket.
- Remove the 4 bolts and timing belt cover.

21. REMOVE TIMING BELT GUIDE

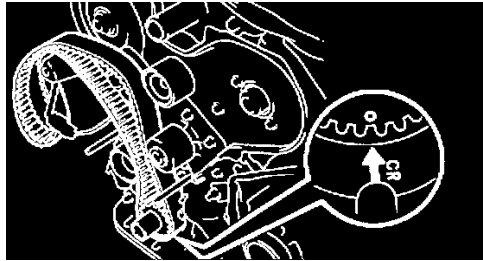

22. REMOVE TIMING BELT

HINT: When re-using timing belt: If the installation marks have disappeared, place a new installation mark on the timing belt to match the drilled mark of the crankshaft timing pulley.

23. REMOVE NO. 2 IDLER PULLEY AND NO. 1 IDLER PULLEY

- Remove the bolt and No. 2 idler pulley.
- Using a 10 mm hexagon wrench, remove the pivot bolt, No. 1 idler pulley and plate washer.

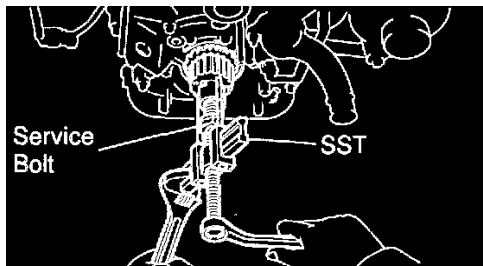

24. REMOVE CRANKSHAFT TIMING PULLEY

Remove the crankshaft timing pulley.

HINT: If the pulley cannot be removed by hand, use SST and service bolt to remove the crankshaft timing pulley.

SST 09950-50013 (09951-05010, 09952-05010, 09953-05020, 09954-05011)

INSPECTION



1. INSPECT TIMING BELT

NOTICE: Do not bend, twist or turn the timing belt inside out. Do not allow the timing belt to come into contact with oil, water or steam. Do not utilize timing belt tension when installing or removing the mount bolt of the camshaft timing pulley.

If there is any defect, as shown in the illustration, check these points:

- a. Premature parting.
 - ^ Check for proper installation.
 - ^ Check the timing cover gasket for damage and proper installation.
- b. If the belt teeth are cracked or damaged, check to see if either camshaft is locked.
- c. If there is noticeable wear or cracks on the belt face, check to see if there are nicks on the side of the idler pulley lock and water pump.
- d. If there is wear or damage on even one side of the belt, check the belt guide and the alignment of each pulley.
- e. If there is noticeable wear on the belt teeth, check timing cover for damage and check that gasket has been installed correctly and for foreign material on the pulley teeth. If necessary, replace the timing belt.

2. INSPECT IDLER PULLEYS

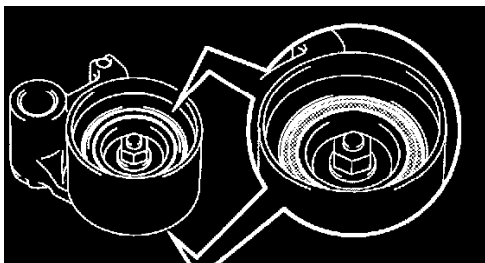

- a. Visually check the seal portion of the idler pulley for oil leakage. If leakage is found, replace the idler pulley.

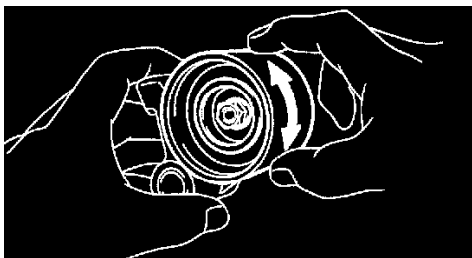

- b. Check that the idler pulley turns smoothly. If necessary, replace the idler pulley.

3. INSPECT TIMING BELT TENSIONER

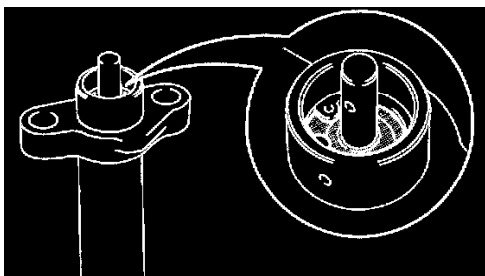

- a. Visually check the seal portion of the tensioner for oil leakage.

HINT: If there is only the faintest trace of oil on the seal on the push rod side, the tensioner is all right. If leakage is found, replace the tensioner.



- b. Hold the tensioner with both hands and push the push rod strongly as shown to check that it doesn't move. If the push rod moves, replace the tensioner.

NOTICE: Never hold the tensioner push rod facing downward.

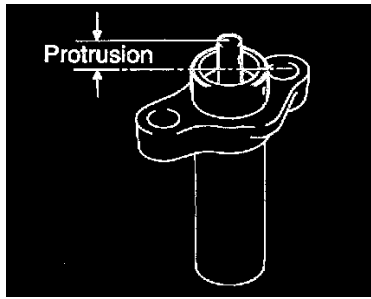

- c. Measure the protrusion of the push rod from the housing end.
 Protrusion: **10.0 - 10.8 mm (0.394 - 0.425 inch)**
 If the protrusion is not as specified, replace the tensioner.

INSTALLATION

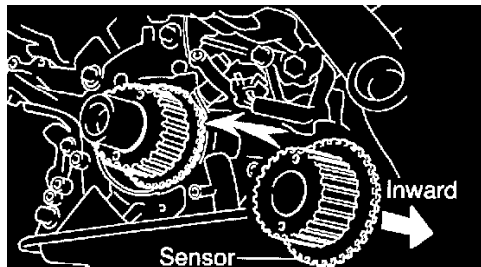

1. INSTALL CRANKSHAFT TIMING PULLEY

- Align the pulley set key with the key groove of the timing pulley and slide it on the timing pulley.
- Slide on the timing pulley, facing the flange side inward.

NOTICE: Do not scratch the sensor part of the crankshaft timing pulley.

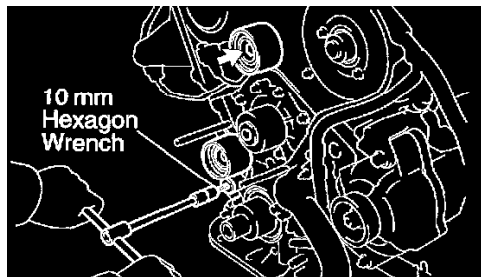

2. INSTALL NO.1 IDLER PULLEY AND NO.2 IDLER PULLEY

- Using a 10 mm hexagon wrench, install the No. 1 idler pulley with the plate washer and bolt.
 Torque: **35 Nm (350 kgf-cm, 26 ft. lbs.)**
- Check that the pulley bracket moves smoothly.
- Install the No. 2 idler pulley with the bolt.
 Torque: **40 Nm (400 kgf-cm, 30 ft. lbs.)**
- Check that the pulley moves smoothly.

3. TEMPORARILY INSTALL TIMING BELT

NOTICE: The engine should be cold.

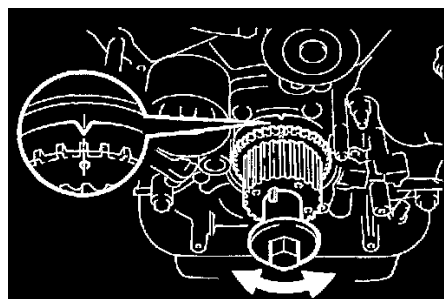

- a. Use the crankshaft pulley bolt to turn the crankshaft and align the timing marks on the crankshaft timing pulley and on the oil pump body.
- b. Remove any oil or water on the crankshaft timing pulley, idler pulley and water pump pulley, and keep them clean.

NOTICE: Only wipe the pulleys; do not use any cleansing agent.

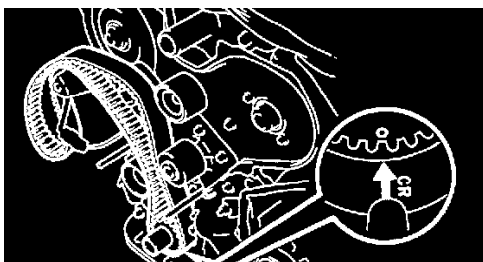

- c. Align the installation mark on the timing belt with the drilled mark of the crankshaft timing pulley.
- d. Install the timing belt on the crankshaft timing pulley, No. 1 idler pulley and water pump pulley.

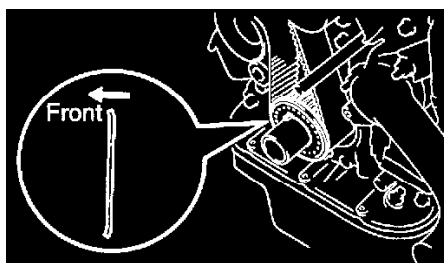

4. INSTALL TIMING BELT GUIDE

Install the guide, facing the cup side outward.

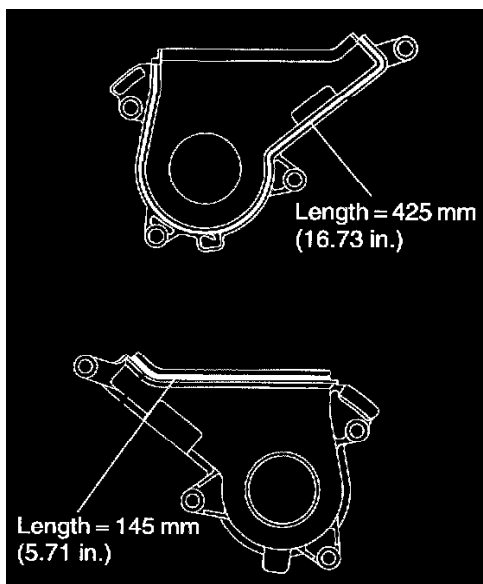

5. INSTALL NO. 1 TIMING BELT COVER AND STARTER WIRE BRACKET

- a. Check that the timing belt cover gaskets have cracks or peeling, etc. If the gasket does have cracks or peeling, etc., replace it using these steps.
 1. Using a screwdriver and gasket scraper, remove all the old gasket materials.
 2. Thoroughly clean all components to remove all the loose material.
 3. Remove the backing paper from a new gasket and install the gasket evenly to the part of the belt cover shaded back in the illustration.
- b. Install the timing belt cover with the 4 bolts.
Torque: **9 Nm (90 kgf-cm, 80 inch lbs.)**
- c. Install the starter wire bracket with the 2 bolts.

6. INSTALL CRANKSHAFT PULLEY

- a. Align the pulley set key with the key groove of the pulley, and slide it on the pulley.

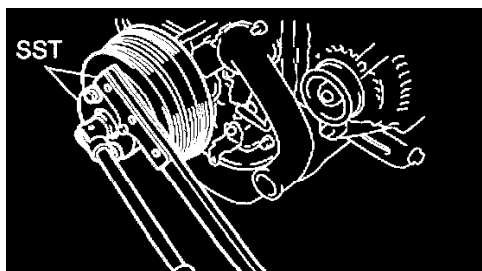

- b. Using SST, install and torque the bolt.
 SST 09213-54015 (90119-08216), 09330-00021
 Torque: **295 Nm (2,950 kgf-cm, 217 ft. lbs.)**

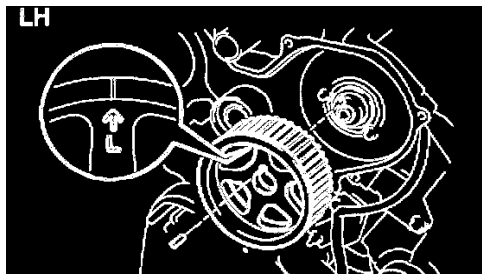

7. INSTALL LH CAMSHAFT TIMING PULLEY

- Slide the timing pulley, facing the flange side outward.
- Align the knock pin hole of the camshaft with the knock pin groove of the timing pulley as shown.
- Install the knock pin.
- Using SST, install and torque the bolt.
 SST 09960-10010 (09962-01000, 09963-01000)
 Torque: **110 Nm (1,100 kgf-cm, 81 ft. lbs.)**

8. SET NO. 1 CYLINDER TO TDC/COMPRESSION

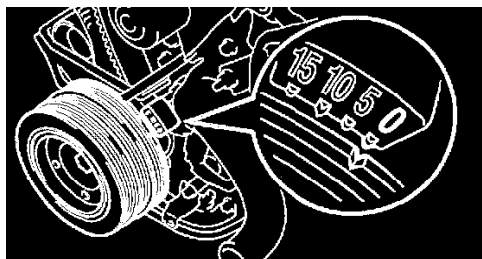

- Crankshaft Position:**
 Turn the crankshaft pulley, and align its groove with the "0" timing mark of the No. 1 timing belt cover.

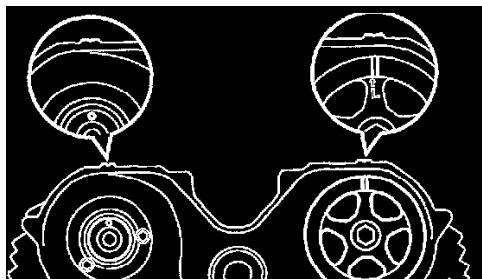

- RH Camshaft Position:**
 Turn the camshaft, align the knock pin hole of the camshaft with the timing mark of the No. 3 timing belt cover.
- LH Camshaft Pulley Position:**
 Turn the camshaft timing pulley, align the timing marks of the camshaft timing pulley and No. 3 timing belt cover.

9. INSTALL TIMING BELT TO LH CAMSHAFT TIMING PULLEY



HINT: When re-using timing belt: Check that the installation mark on the timing belt matches the end of the No. 1 timing belt cover. If the installation mark do not align, shift the meshing of the timing belt and crankshaft timing pulley until they align.

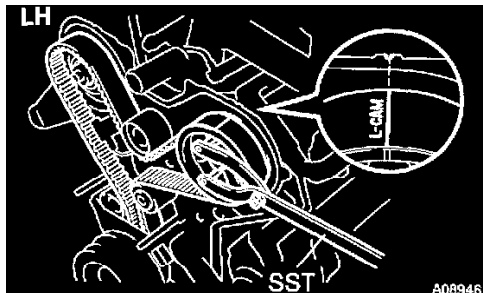

- a. Remove any oil or water on the LH camshaft timing pulley, and keep it clean.
- b. Using SST, slightly turn the LH camshaft timing pulley clockwise. Align the installation mark on the timing belt with the timing mark of the camshaft timing pulley, and hang the timing belt on the LH camshaft timing pulley.
SST 09960-10010 (09962-01000, 09963-01000)

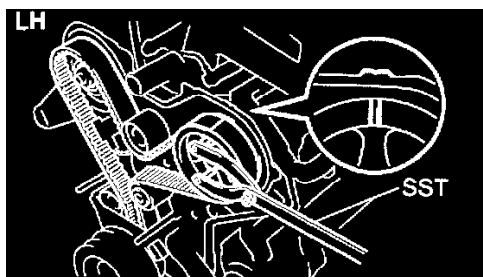

- c. Using SST, align the timing marks of the LH camshaft pulley and No. 3 timing belt cover.
SST 09960-10010 (09962-01000, 09963-01000)
- d. Check that the timing belt has tension between the crankshaft timing and LH camshaft timing pulleys.

10. INSTALL RH CAMSHAFT TIMING PULLEY AND TIMING BELT

- a. Remove any oil or water on the RH camshaft timing and No. 2 idler pulleys, and keep them clean.

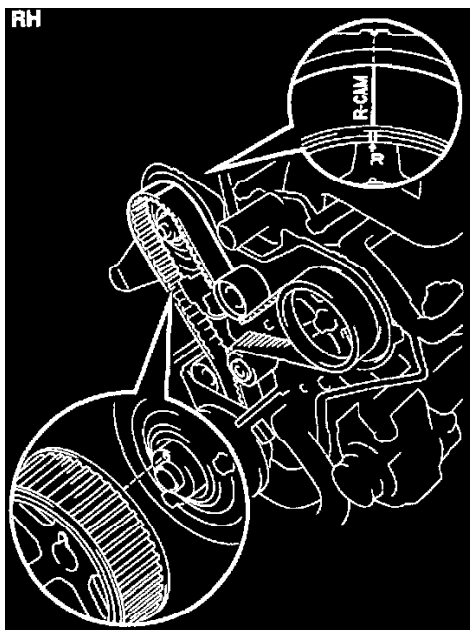

- b. Align the installation mark on the timing belt with the timing mark of the RH camshaft timing pulley as shown.
- c. Hang the timing belt on the RH camshaft timing pulley.
- d. Align the timing marks of the RH camshaft timing pulley and No. 3 timing belt cover.
- e. Slide the RH camshaft timing pulley on the camshaft.

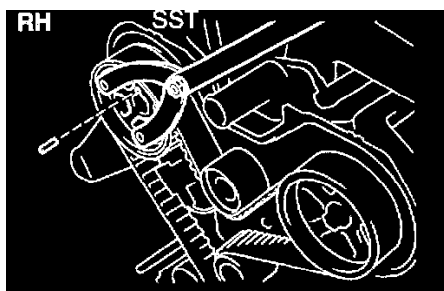

- f. Using SST, align the knock pin hole of the camshaft with the knock pin groove marked R of the pulley and install the knock pin.
SST 09960-10010 (09962-01000, 09963-01000)
- g. Using SST, install and torque the bolt.
SST 09960-10010 (09962-01000, 09963-01000)
Torque: **110 Nm (1,100 kgf-cm, 81 ft. lbs.)**

11. SET TIMING BELT TENSIONER

- a. Using a press, slowly press in the push rod using **981 - 9,807 N (100 - 1,000 kgf, 220 - 2,205 ft. lbs.)** of pressure.

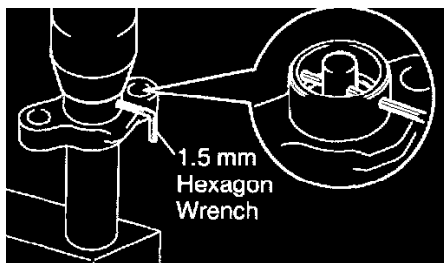

- b. Align the holes of the push rod and housing, pass a 1.5 mm hexagon wrench through the holes to keep the setting position of the push rod.
- c. Release the press.

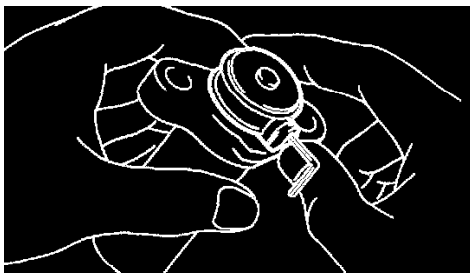

- d. Install the dust boot to the tensioner.

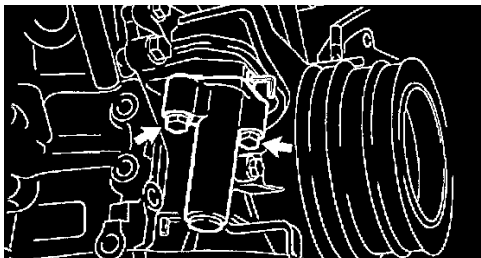

12. INSTALL TIMING BELT TENSIONER

- a. Install the tensioner with the 2 bolts.
Torque: **27 Nm (275 kgf-cm, 20 ft. lbs.)**
- b. Remove the 1.5 mm hexagon wrench from the tensioner.

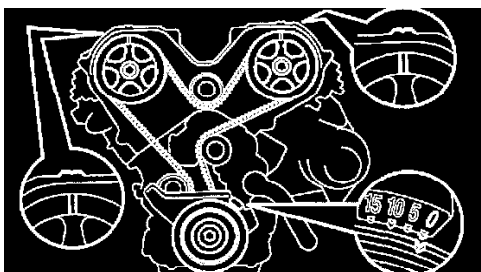

13. CHECK VALVE TIMING

- a. Turn the crankshaft pulley **2 revolutions** from TDC to TDC.

NOTICE: Always turn the crankshaft clockwise.

- b. Check that each pulley aligns with the timing marks as shown in the illustration. If the marks do not align, remove the timing belt and reinstall it.



14. INSTALL FAN BRACKET

- a. Install the fan bracket with the bolt and nut.
- b. Install the PS pump adjusting strut with the nut.

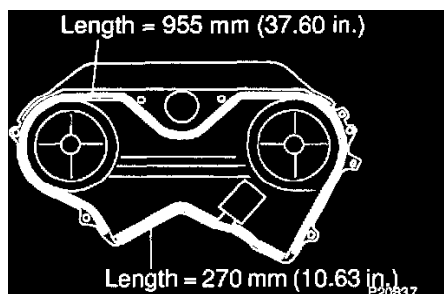

15. INSTALL NO.2 TIMING BELT COVER

- a. Check that the timing belt cover gasket has no cracks or peeling, etc. If the gasket does have cracks or peeling, etc., replace it using these steps.
 1. Using a screwdriver and gasket scrapers, remove all the old gasket materials.
 2. Thoroughly clean all components to remove all the loose material.
 3. Remove the backing paper from a new gasket and install the gasket evenly to the part of the belt cover shaded black in the illustration.
- b. Install the belt cover with the 6 bolts.
Torque: **9 Nm (90 kgf-cm, 80 inch lbs.)**
- c. Connect the 4 high-tension cord clamps to the No. 2 timing belt cover.
- d. Connect the camshaft position sensor connector to the No. 2 timing belt cover.

16. w/ A/C:

INSTALL A/C COMPRESSOR BRACKET

Torque: **47 Nm (479 kgf-cm, 35 ft. lbs.)**

17. TEMPORARILY INSTALL FAN WITH FLUID COUPLING AND FAN PULLEYS

18. INSTALL NO.2 FAN SHROUD

19. INSTALL AND ADJUST DRIVE BELT FOR GENERATOR

20. TIGHTEN FAN WITH FLUID COUPLING AND FAN PULLEYS

Torque: **5.4 Nm (54 kgf-cm, 48 inch lbs.)**

21. w/ A/C:

CONNECT A/C COMPRESSOR TO ENGINE

- a. Install the A/C compressor with the 4 bolts.

Torque: **25 Nm (250 kgf-cm, 18 ft. lbs.)**

- b. Install and adjust the drive belt.
- c. Connect the A/C compressor connector.

22. CONNECT PS PUMP TO ENGINE

- a. Temporarily install the PS pump with the bolt and nut.
- b. Install and adjust the drive belt.
- c. Tighten the bolt and nut.
Torque: **43 Nm (440 kgf-cm, 31 ft. lbs.)**
- d. Install the PS pressure tube clamp with the bolt.
- e. Connect the 2 PS air hoses to the air intake chamber and resonator.

23. CONNECT UPPER RADIATOR HOSE

24. FILL ENGINE WITH COOLANT

25. START ENGINE CHECK FOR LEAKS

26. INSTALL ENGINE UNDER COVER

27. ROAD TEST VEHICLE

Check for abnormal noise, shock, slippage, correct shift points and smooth operation.

28. RECHECK ENGINE COOLANT LEVEL CYLINDER HEAD